

# РЕВЕРСИВНЫЙ МОТОР - СЕРИИ XV

**XV-3M**

**ВАЛ ШЛИЦЕВОЙ  
ФЛАНЕЦ Ø101,6 ТИП "SAE B"**

**X 3 M 78 31 I E E E**

Серия	X	Серия XV
Группа	3	Группа 3
Категория	M	Ревёрсивный мотор
Рабочий объем	78	38
Фланец	31	Ø101,6 Тип "SAE B" с реверсивным вращением
Вал	I	SCF04- Вал шлицевой - Ø21,81 z=13 H=33,55 SAE J498-13T 16/32DP (SAE B)
Корпус	Вход	Входной канал - 1" BSPP
	Выход	Выходной канал - 1" BSPP
Крышка	E	С внешним сливом

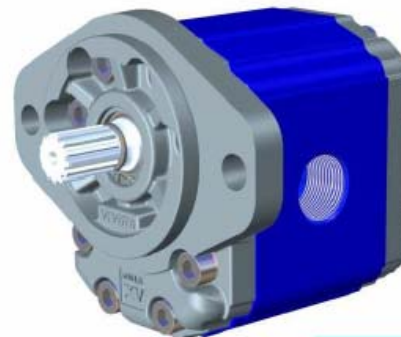

**XM331**

**Таблица технических характеристик**

ТИП	Раб. Об. См³ /об	Макс. Давление		КОД																	
		P1 бар	P3 бар	Внешний слив								Внутренний слив									
				X	3	M	66	31	I	D	D	E	X	3	M	66	31	I	D	D	F
XV-3M/15	14,89	250	270	X	3	M	66	31	I	D	D	E	X	3	M	66	31	I	D	D	F
XV-3M/18	17,37	250	270	X	3	M	68	31	I	D	D	E	X	3	M	68	31	I	D	D	F
XV-3M/21	21,10	250	270	X	3	M	70	31	I	D	D	E	X	3	M	70	31	I	D	D	F
XV-3M/27	26,97	250	270	X	3	M	72	31	I	E	E	E	X	3	M	72	31	I	E	E	F
XV-3M/32	32,27	250	270	X	3	M	74	31	I	E	E	E	X	3	M	74	31	I	E	E	F
XV-3M/38	38,47	250	270	X	3	M	78	31	I	E	E	E	X	3	M	78	31	I	E	E	F
XV-3M/43	43,44	250	270	X	3	M	79	31	I	E	E	E	X	3	M	79	31	I	E	E	F
XV-3M/47	47,16	230	250	X	3	M	80	31	I	E	E	E	X	3	M	80	31	I	E	E	F
XV-3M/51	50,88	230	250	X	3	M	81	31	I	E	E	E	X	3	M	81	31	I	E	E	F
XV-3M/54	54,60	230	250	X	3	M	82	31	I	E	E	E	X	3	M	82	31	I	E	E	F
XV-3M/61	60,81	230	250	X	3	M	83	31	I	F	F	E	X	3	M	83	31	I	F	F	F
XV-3M/64	64,53	210	230	X	3	M	85	31	I	F	F	E	X	3	M	85	31	I	F	F	F
XV-3M/70	70,74	200	220	X	3	M	86	31	I	F	F	E	X	3	M	86	31	I	F	F	F
XV-3M/74	74,46	180	200	X	3	M	87	31	I	F	F	E	X	3	M	87	31	I	F	F	F
XV-3M/90	86,87	150	170	X	3	M	89	31	I	F	F	E	X	3	M	89	31	I	F	F	F

P1) Макс. рабочее давление - P3) Макс. пиковое давление

Для работы мотора в тяжелом режиме рекомендуется проверять допустимый крутящий момент на валу.

**Таблица габаритов**

ТИП	Вес кг	A мм	B мм	D	
				ВХОД	ВЫХОД
XV-3M/15	7,010	124,0	61,0	3/4" BSPP	3/4" BSPP
XV-3M/18	7,070	126,0	62,0	3/4" BSPP	3/4" BSPP
XV-3M/21	7,150	129,0	63,5	3/4" BSPP	3/4" BSPP
XV-3M/27	7,250	133,0	65,5	1" BSPP	1" BSPP
XV-3M/32	7,390	138,0	68,0	1" BSPP	1" BSPP
XV-3M/38	7,520	143,0	70,5	1" BSPP	1" BSPP
XV-3M/43	7,630	147,0	72,5	1" BSPP	1" BSPP
XV-3M/47	7,710	150,0	74,0	1" BSPP	1" BSPP
XV-3M/51	7,790	153,0	75,5	1" BSPP	1" BSPP
XV-3M/54	7,870	156,0	77,0	1" BSPP	1" BSPP
XV-3M/61	8,010	161,0	79,5	1" 1/4 BSPP	1" 1/4 BSPP
XV-3M/64	8,090	164,0	81,0	1" 1/4 BSPP	1" 1/4 BSPP
XV-3M/70	8,220	169,0	83,5	1" 1/4 BSPP	1" 1/4 BSPP
XV-3M/74	8,300	172,0	85,0	1" 1/4 BSPP	1" 1/4 BSPP
XV-3M/90	8,570	182,0	90,0	1" 1/4 BSPP	1" 1/4 BSPP

T.1 = 60÷65 [Н·м] - крутящий момент затяжки винтов M10

T.2 = 264 [Н·м] - допустимый крутящий момент на валу

(Примечание: Выбирая вал, всегда проверяйте допустимый крутящий момент).

T.4 = 0,3÷0,5 бар - максимальное давление на сливе.

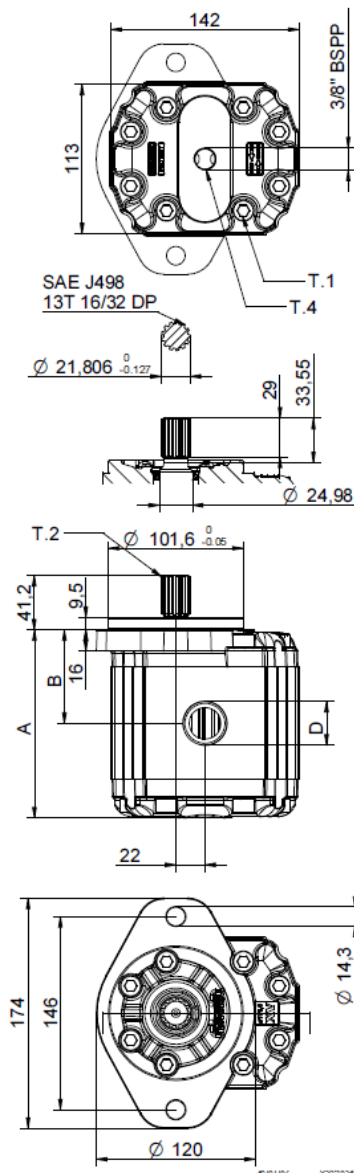

ФЛАНЕЦ Ø101,6 ТИП "SAE В"

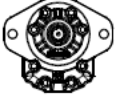
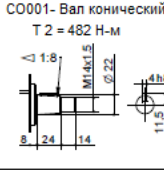
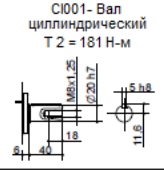
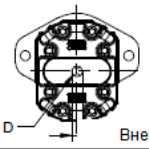
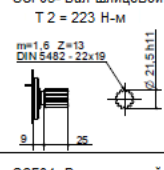
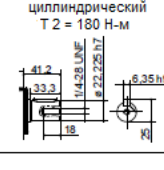
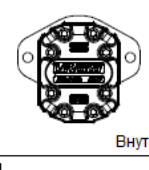
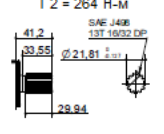
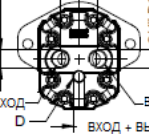
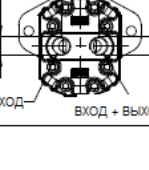
Фланец Ø101,6 Тип "SAE В"		Вал		Крышка			
	31	CO001- Вал конический T 2 = 482 Н-м 	A	C1001- Вал цилиндрический T 2 = 181 Н-м 	B	 Внешний Слив	E
		SCF03- Вал шлицевой T 2 = 223 Н-м 	C	C1004- Вал цилиндрический T 2 = 180 Н-м 	H	 Внутренний Слив	F
		SCF04- Вал шлицевой T 2 = 264 Н-м 	I			 ВХОД + ВЫХОД + ВНЕШНИЙ СЛИВ	K
						 ВХОД + ВЫХОД + ВНУТРЕННИЙ СЛИВ	L

Типоразмер	
ТИП	КОД
XV-3M/15	66
XV-3M/18	68
XV-3M/21	70
XV-3M/27	72
XV-3M/32	74
XV-3M/38	78
XV-3M/43	79
XV-3M/47	80
XV-3M/51	81
XV-3M/54	82
XV-3M/61	83
XV-3M/64	85
XV-3M/70	86
XV-3M/74	87
XV-3M/90	89

Стандартные корпуса				
Рабочий Объем См <sup>3</sup> /об	Стандартные резьбы			
	15	A - A	D - D	H - H
18	A - A	D - D	H - H	
21	A - A	D - D	H - H	
27	A - A	E - E	H - H	
32	B - B	E - E	H - H	
38	B - B	E - E	H - H	
43	B - B	E - E	H - H	
47	B - B	E - E	H - H	
51	B - B	E - E	H - H	
54	B - B	E - E	H - H	
61	C - C	F - F		
64	C - C	F - F		
70	C - C	F - F		
74	C - C	F - F		
90	C - C	F - F		

В таблице указаны имеющиеся в ассортименте комбинации стандартных фланцев и резьб.

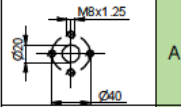
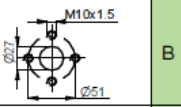
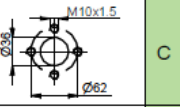
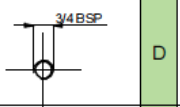
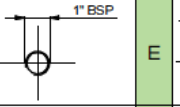
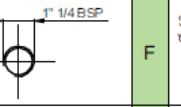
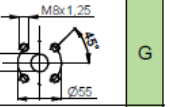
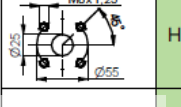
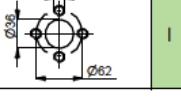
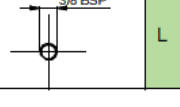
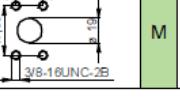
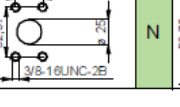
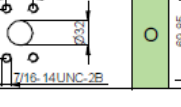
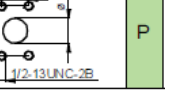
Корпус (резьбы/фланцы)													
	A		B		C		D		E		F		G
	H		I		L		M		N		O		P
Закрытый Корпус	Z												